



**MITSUBISHI
ELECTRIC**

Changes for the Better

for a greener tomorrow



MELSEC iQ-F Series
iQ Platform-compatible PLC

The next level of industry

MELSEC iQ-F
series



MELSEC iQ-F series

Witness the evolution of the micro PLC.

Designed on the concepts of outstanding performance, superior drive control, and user centric programming,

Mitsubishi's MELSEC-F Series has been reborn as the MELSEC iQ-F Series.



The next level of industry

From stand alone use to networked system application, MELSEC iQ-F Series brings your business to the next level of industry.



Conveyance



Food & Beverage

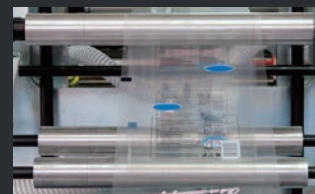

Packaging



Air-conditioning

New micro PLC designed on the concepts of...



Outstanding Performance

- Completely redesigned, high speed system bus
- Extensive built-in functions
- Enhanced security functions



Superior Drive Control

- Built-in positioning (4-Axis 200 kHz)
- Simple linear interpolation (2-Axis simultaneous start)
- Synchronous control with Simple Motion unit (4-Axis)
- No need for dedicated positioning software



Intuitive Programming Environment

- Easy programming by drag and drop
- Reduced development time with module FB
- Parameterized setup for a variety of functions



GX Works3



FX5

iQ Platform

iQ Platform for maximum return on investment

Minimize Total cost, Seamless integration, Maximize productivity, Transparent communications: these are common items that highlight the benefits of the iQ Platform. Enhanced further with the arrival of the new MELSEC iQ-F Series Programmable Logic Controller (PLC), reducing costs and improving productivity can be realized even easier. The iQ Platform minimizes TCO at all phases of the automation life cycle by improving development times, enhancing productivity, reducing maintenance costs, and making information more easily accessible.

PLC & HMI

1. The new MELSEC iQ-F Series system bus is 150-times faster realizing improved system performance
2. Program standardization through function blocks and module labels
3. Powerful and robust security features

Network

1. CC-Link IE Field, 1Gbps high-speed and large bandwidth communications network
2. Seamless connectivity within all levels of manufacturing with SLMP

Engineering

1. Automatic generation of network configuration diagram
2. Share parameters across multiple engineering software via MELSOFT Navigator



iQ Platform

MELSEC iQR

GOT2000

PLC & HMI



Network

Engineering environment

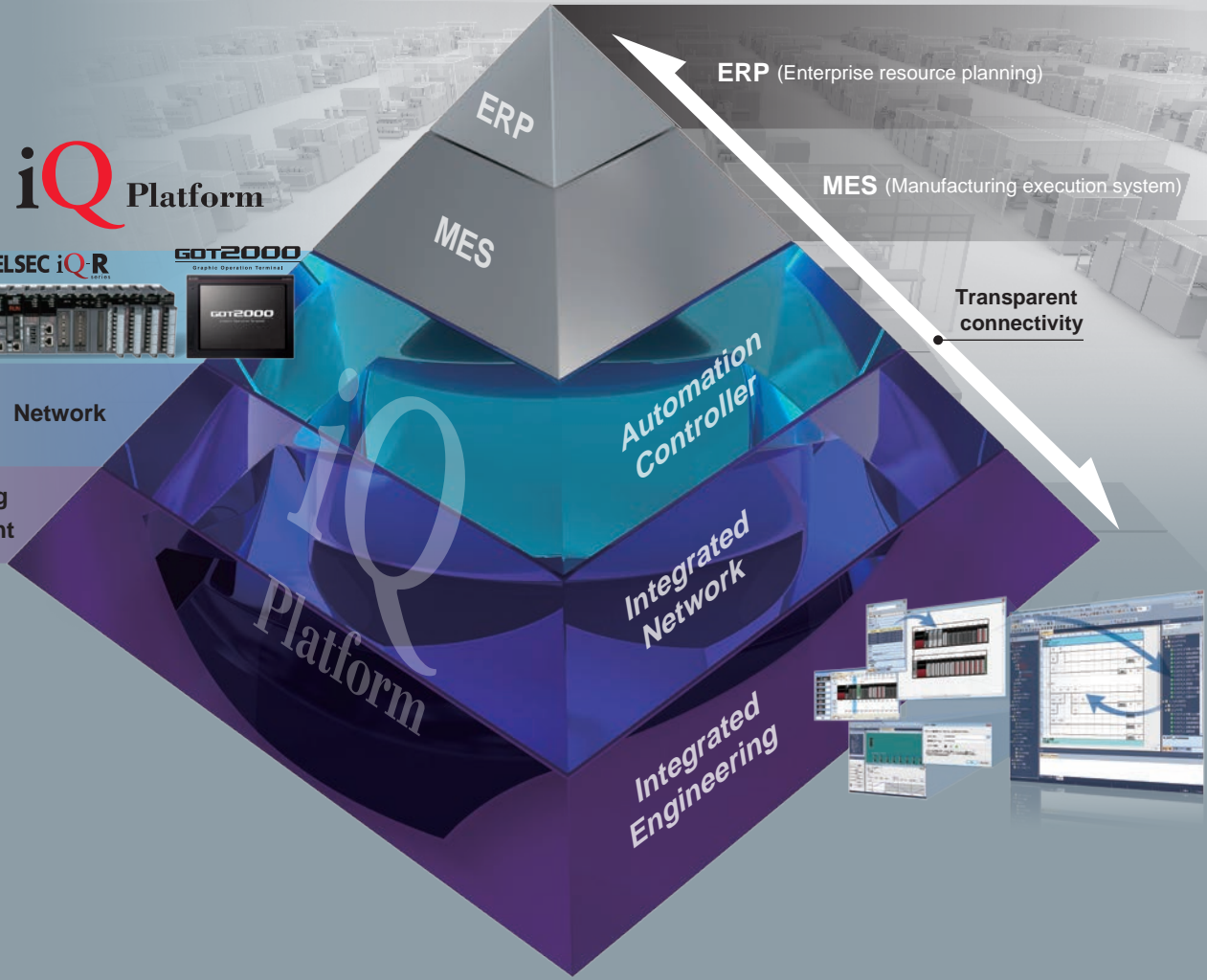

Integrated Functions

Built-in Analog

Integrated 2 ch analog input and 1 ch analog output (12 bit 0-10V DC input/output)

FX5U is equipped with analog control capabilities right out of the box. No ladder logic is required when using parameter setting in the programming software.

» Example of analog application with 2AD and 1DA.

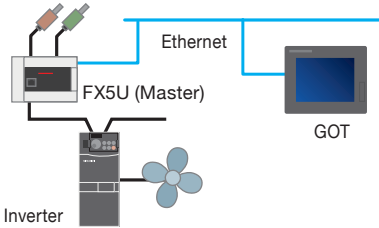

Built-in SD Card Slot

Standard external memory

External memory is useful for updating PLCs in the field.

Program can be loaded onto SD card and then transferred to as many PLCs as necessary.

SD card can also be used for data logging. Record keeping is important for data analysis and tracking machine performance.

... Future support

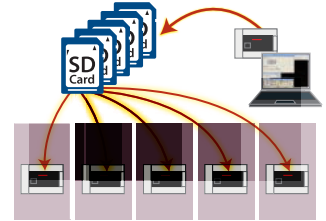

RUN/STOP/RESET Switch

The run/stop switch conveniently includes the same reset functionality found on high end devices.

PLC can be rebooted without turning off the main power for efficient debugging.

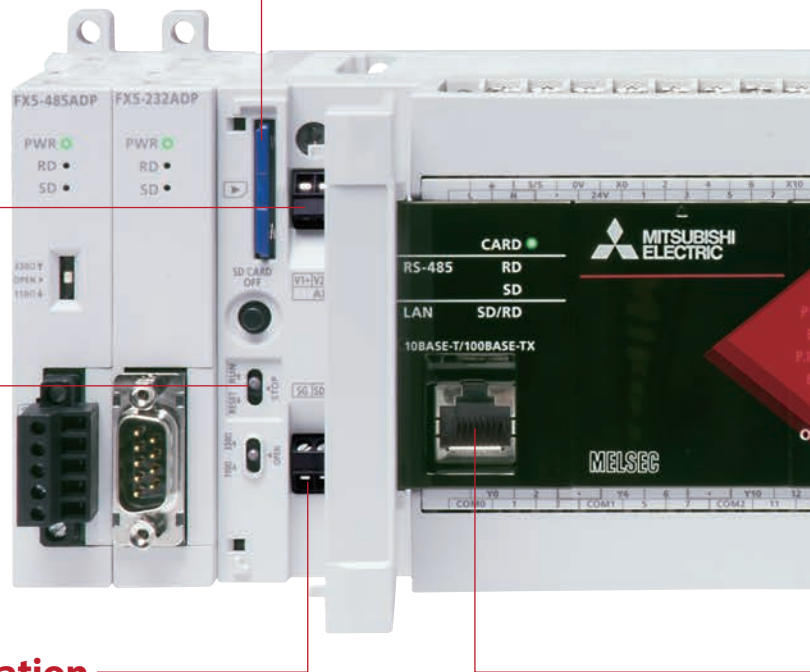

Built-in RS-485(MODBUS®) Communication

No need for additional options for RS-485 communication

For related systems and data transfer with external equipment and third party devices, serial communication has long been the established connection method. Serial communication allows the FX5U to connect both efficiently and reliably with other PLCs, sensors, printers, and modems, etc. Multi-drop networks, non-protocol communication, and remote maintenance are just some of the many uses.

» Inverter Communication

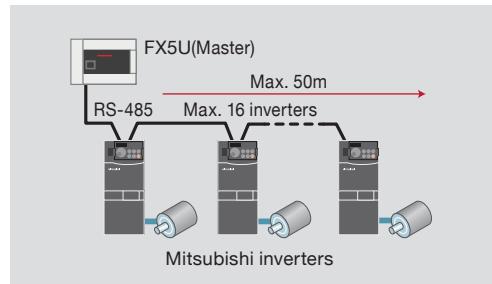

» MODBUS Communication

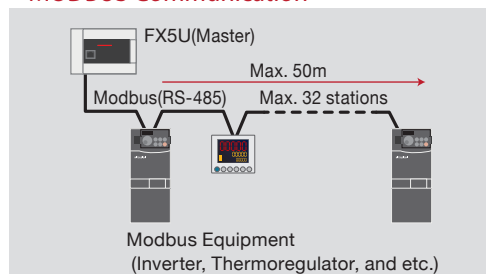

Security

MELSEC iQ-F provides advanced security functions (file password, remote password, security key) for protection against unauthorized access.

» Example of Security key function.

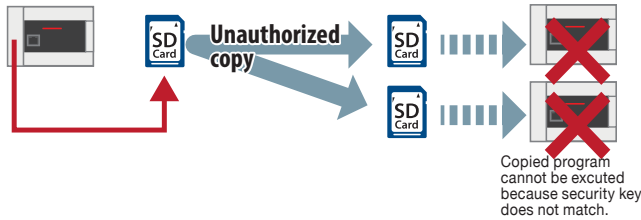

High-speed System Bus

The MELSEC iQ-F high speed system bus provides seamless data transfer from/to the CPU.

With new architecture that realizes data speeds of 1.5 k words per ms (150-times faster than FX3U), fast response is guaranteed even when using expansion modules.

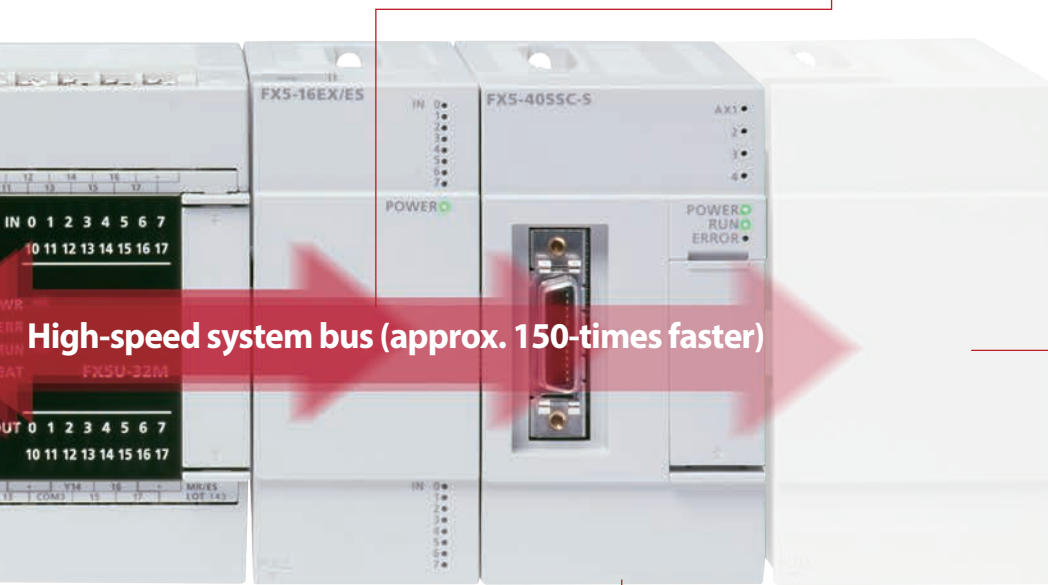

High-speed system bus (approx. 150-times faster)

CC-Link IE slave Module

... Future support

SSNET III/H

Built-in Ethernet port Built-in Ethernet supporting 8 ch

In the information age, Ethernet has become the personal, commercial and industrial standard for easy and efficient data transfer. Whether it is between multiple PLC systems or PLC and PC servers, industrial users dictate foremost that data must always be consistent even in high-noise environments.

» MODBUS/TCP client *... Coming Soon*

» Socket Communication

Communicate with PLC and other devices.

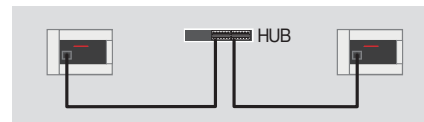

» Remote Maintenance

Program read/write can be made by GX Works3 connected via VPN.

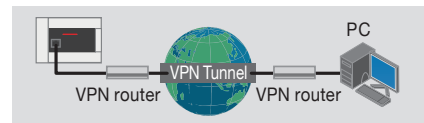

» SLMP Communication

Device data read-out/writing to a PLC from an external device is possible.

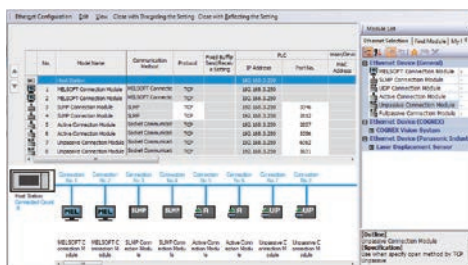
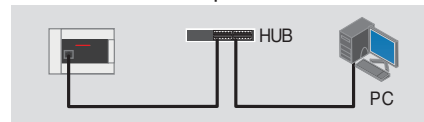

Easy parameter setting

Positioning Solution

Built-in Positioning (4-Axis built-in)

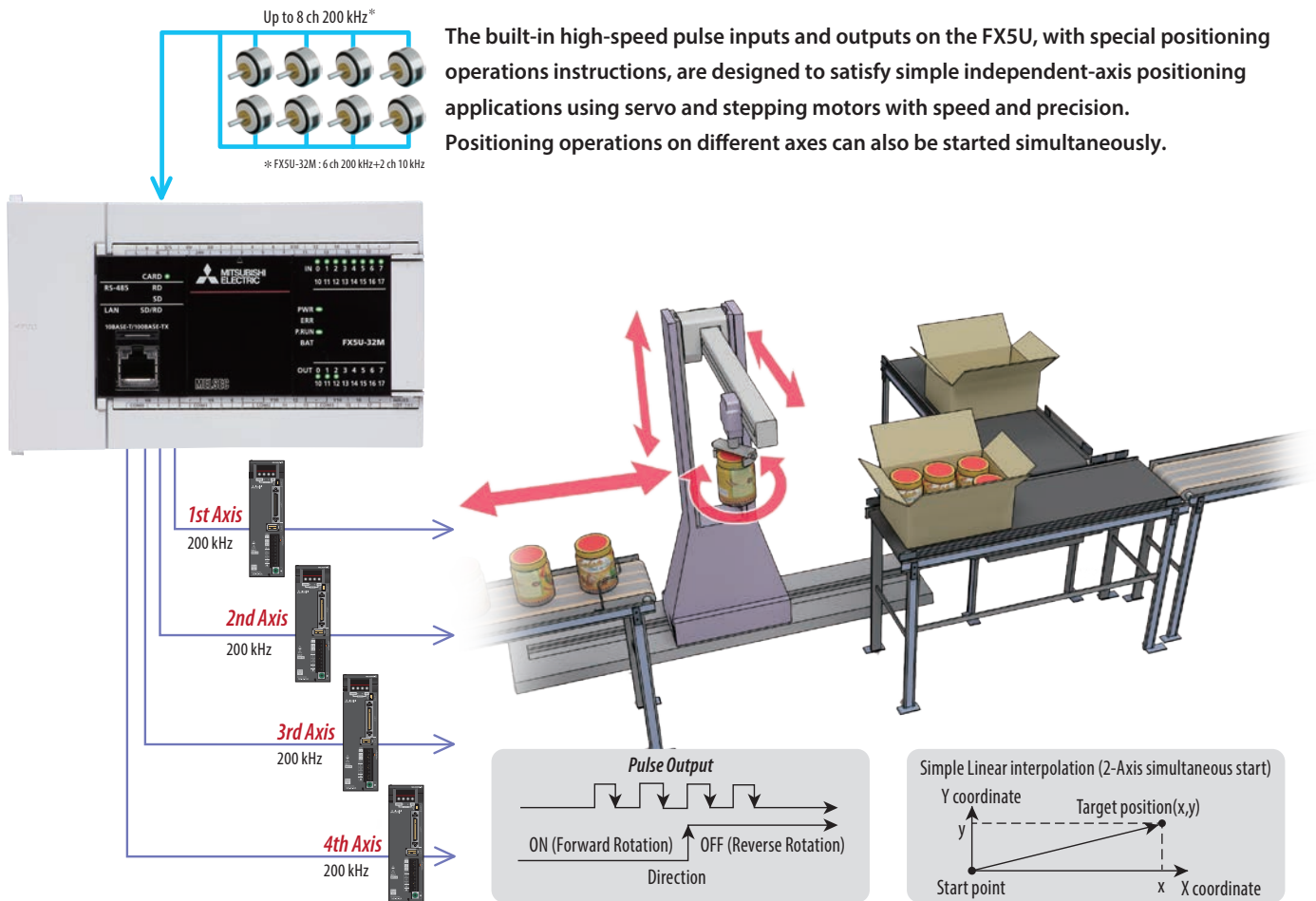

Simple Motion Module (4-Axis module)

Basic Positioning Control

Positioning control is easily executed using a point table.

The machine can coat the workpiece by using a combination of linear interpolation, 2-Axis circular interpolation, and continuous trajectory control.

A smooth trajectory can be traced with the S-curve acceleration/deceleration function.

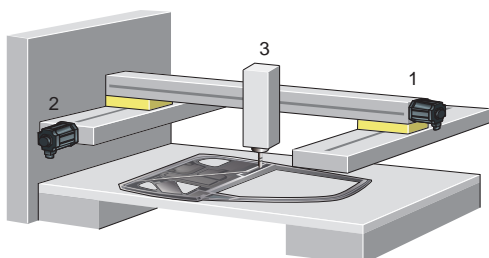

Application examples

- Sealing
- Dispensers

Main functions

- Continuous trajectory control
- Linear interpolation
- Circular interpolation
- S-curve acceleration/deceleration

Advanced Motion Control

Making Simple Motion with compactly packed extra functions

Similar to positioning modules, simple motion modules are capable of a wide range of high-precision control such as positional control, advanced synchronous control, cam control, and speed-torque control with setup being done easily by parameters and programming.

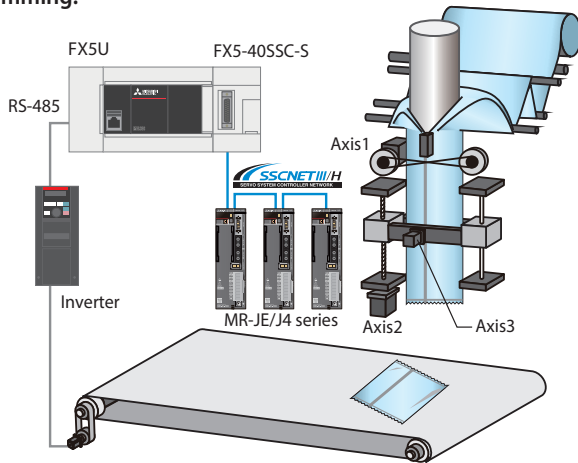

- Use synchronous control and cam functionality to make systems that work continuously and maximize output.
- In a vertical form, fill & seal machine, perform seal and cut while the film is continuously fed.
- With 64 cam profiles available, the same machine can be used for many different packaging styles.

Advanced synchronous control

Software-based synchronous control can be used as an alternative to mechanical control, such as gear, shaft, transmission and cam. In addition, cam control is even easier with cam auto-generation. Synchronous control can be simply operated (start/stop) for each axis, allowing synchronous and positional control axes within the same program.

• Synchronous control

All axes are synchronized using a synchronous encoder or servo input axes. Up to 4 control axes can be synchronized when using the synchronous encoder, such as that used for packaging machines, for example.

Cam auto-generation

Cam data for a rotary cutter can be generated automatically simply by registering the sheet length, synchronization width, rotary cutter axis dimensions, etc.

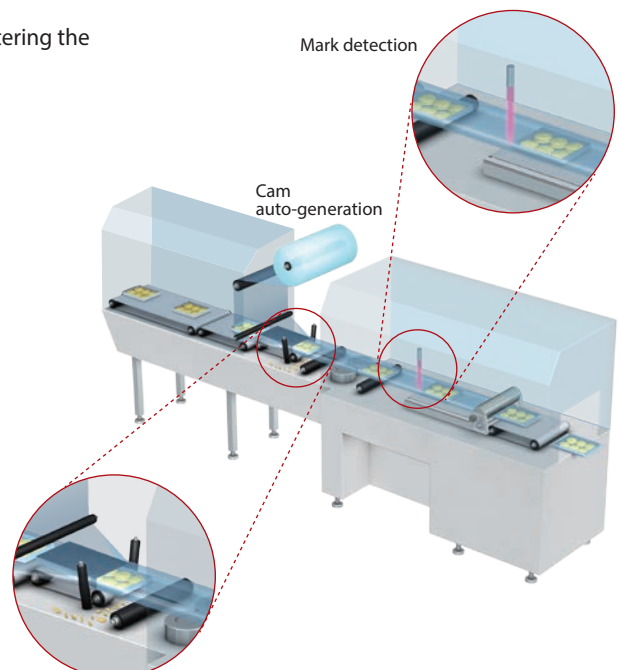
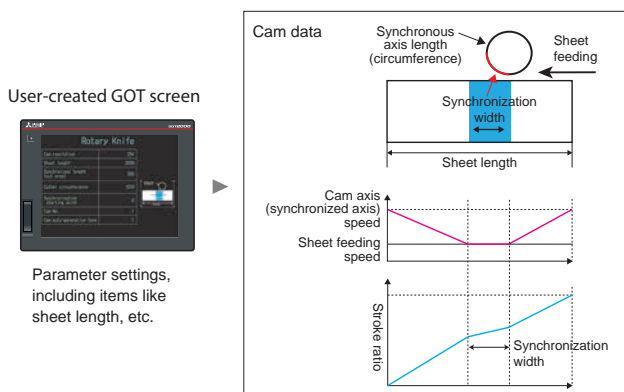

Mark detection

The actual position of the servo motor can be obtained based on the registration mark printed on the high-speed moving film. Compensation of the cutter axis position, based on the registration marks, keeps the constant cutting position.

Engineering Environment

GX Works3

GX Works3 consists of various different components that help to simplify project creation and maintenance tasks. A system design console that enables projects to be created at the system overview stage has been added.

System design with a convenient parts library

Most projects start from system design, so having a software application that caters to this initial stage is important. GX Works3 incorporates a system design feature that enables system components to be assembled directly in the programming software. It includes a parts library consisting of MELSEC iQ-F Series modules that can be used to simplify system creation.

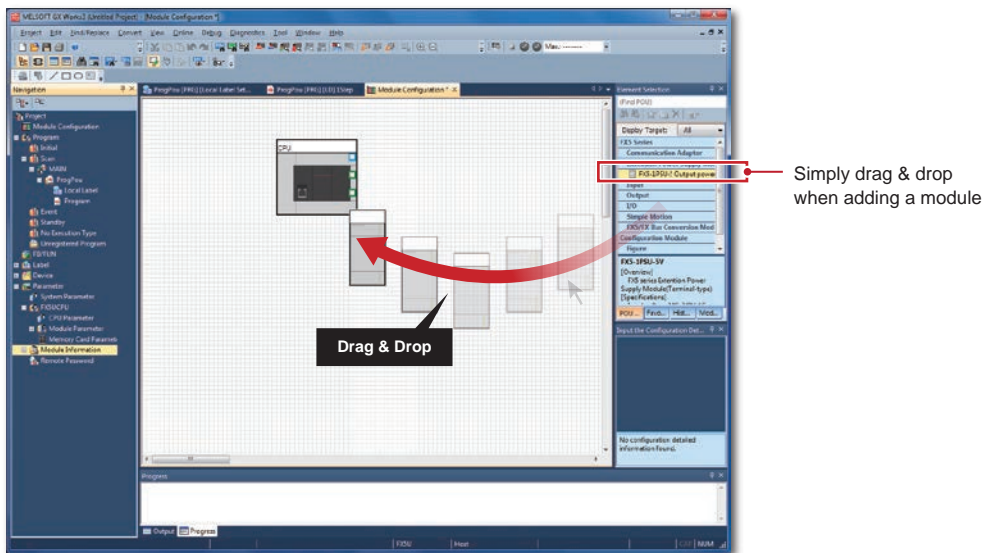

Register module parameters on the fly

Another useful feature is the ability to register parameters automatically. Simply double-click on the desired module and the corresponding parameters will be registered in the project. A window with an easy-to-use parameter settings screen opens, enabling module parameters to be modified as needed.

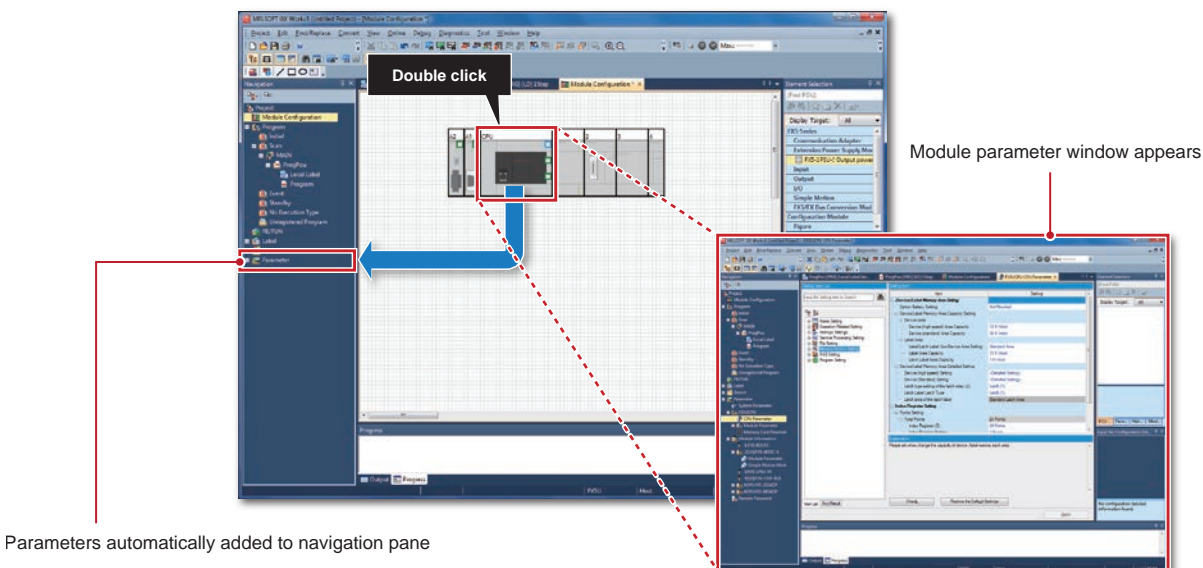

Main programming languages supported

The main IEC languages are supported by GX Works3. Various different programming languages can be used within the same project simultaneously and can be viewed easily via the menu tab. The variables and devices used in each program can be shared across multiple platforms, with user defined function blocks supported.

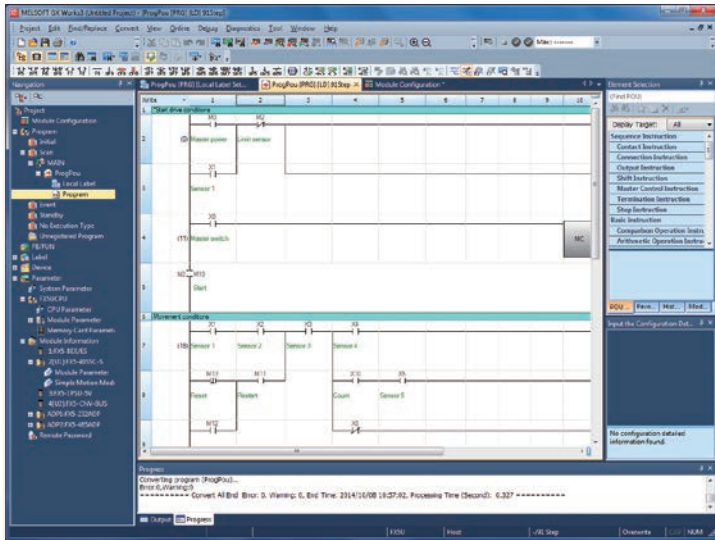

```

100 IF NOT X0 THEN
110   Y0 := TRUE;
120 ELSE
130   Y1 := TRUE;
140 END_IF;
150 // LDFB: Function Block
160 input1 := local1; input2 := K1; input3 := "ABC";
170
180 IF NOT X01 AND X02 THEN
190   IF input1 AND X03 THEN
200     Y01 := TRUE;
210     OUT_T(TG01, TG01, 3);
220   ELSEIF NOT input1 AND input2 THEN
230     Y11 := TRUE;
240     OUT_T(TG01, TG01, 10);
250   ELSE
260     input2 := FALSE;
270     RST(TRUE, T10);
280   END_IF;
290   OUTS OR Z1, Y13;
300 Y10 := FALSE;
310 Y11 := FALSE;
320 IF NOT X03 AND NOT X04 THEN
330   Y10 := TRUE;

```

Structured text

Reduce repetitive program tasks

Global and local variables (labels) are supported providing an easy way to share device names across multiple projects, other MELSOFT software and third party SCADA. The variables can be registered into either the current program, function block as a local variable or within the project as a global variable to share across multiple programs within the same project. Variables specific to a particular module are also available, and can be used immediately, further reducing engineering time and cost.

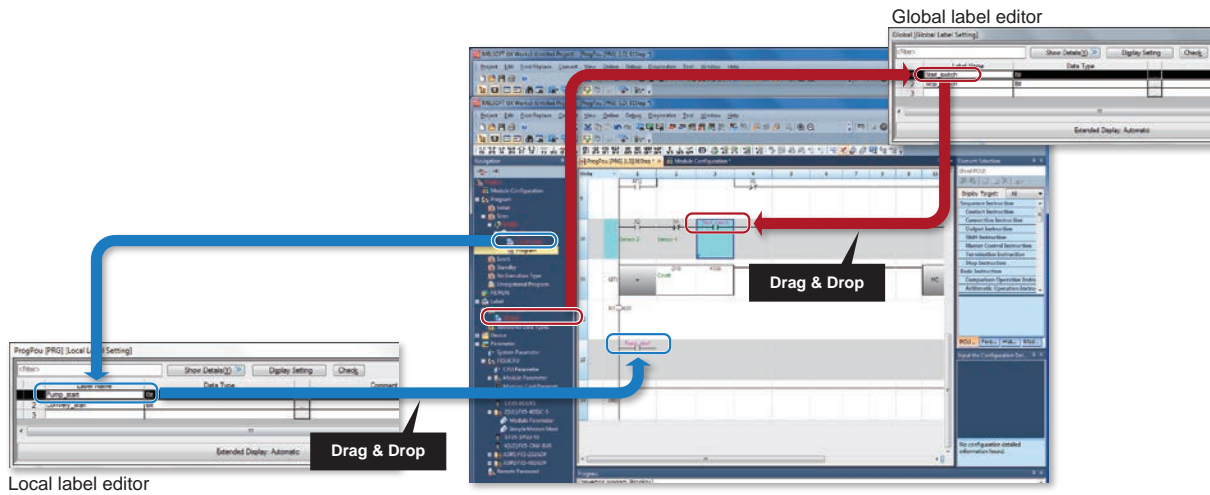

Integrated motion setup tool

GX Works3 is equipped with a special motion setup tool that makes it easy to change simple motion module settings such as module parameters, positioning data and servo parameters. Also, the servo adjustment is simplified using it.

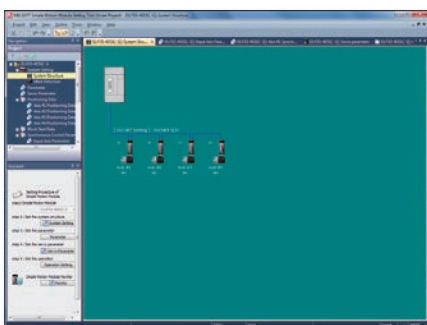

System configuration

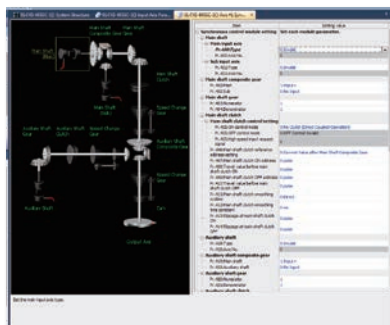

Synchronous Control Parameter

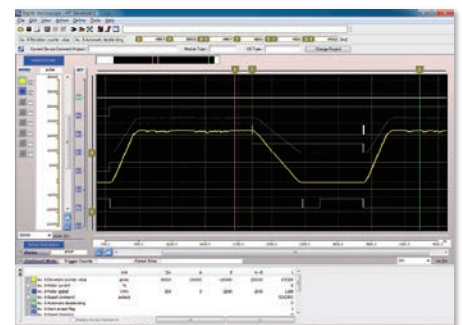

Digital oscilloscope

Flexible Expandability

In addition to its built-in features, FX5U also has a wealth of expansion options.

New communication and analog expansion adapters available!

The Expansion Adapters, also called ADPs, are extremely compact and easy to use. Various are available for serial communication and analog. Compared to the expansion boards, the ADPs offer more flexibility and performance.

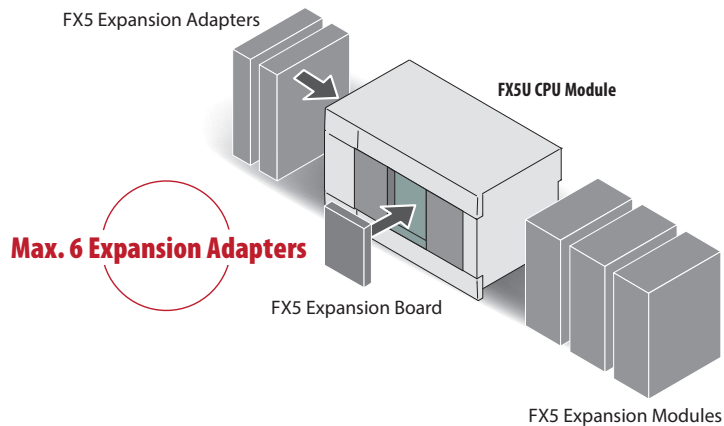

Expansion Adapters

<p>Max. 2 ch</p>  <p>Communication</p> <p>FX5-232ADP FX5-485ADP</p>	<p>Max. 4 ch</p>  <p>Analog</p> <p>FX5-4AD-ADP FX5-4DA-ADP ... Coming Soon</p>
---	--

Expansion Boards

Max. 1 ch



Communication

FX5-232-BD
FX5-485-BD
FX5-422-BD-GOT

FX5U CPU Modules



FX5U-32MR/ES	FX5U-64MR/ES	FX5U-80MR/ES
FX5U-32MT/ES	FX5U-64MT/ES	FX5U-80MT/ES
FX5U-32MT/ESS	FX5U-64MT/ESS	FX5U-80MT/ESS



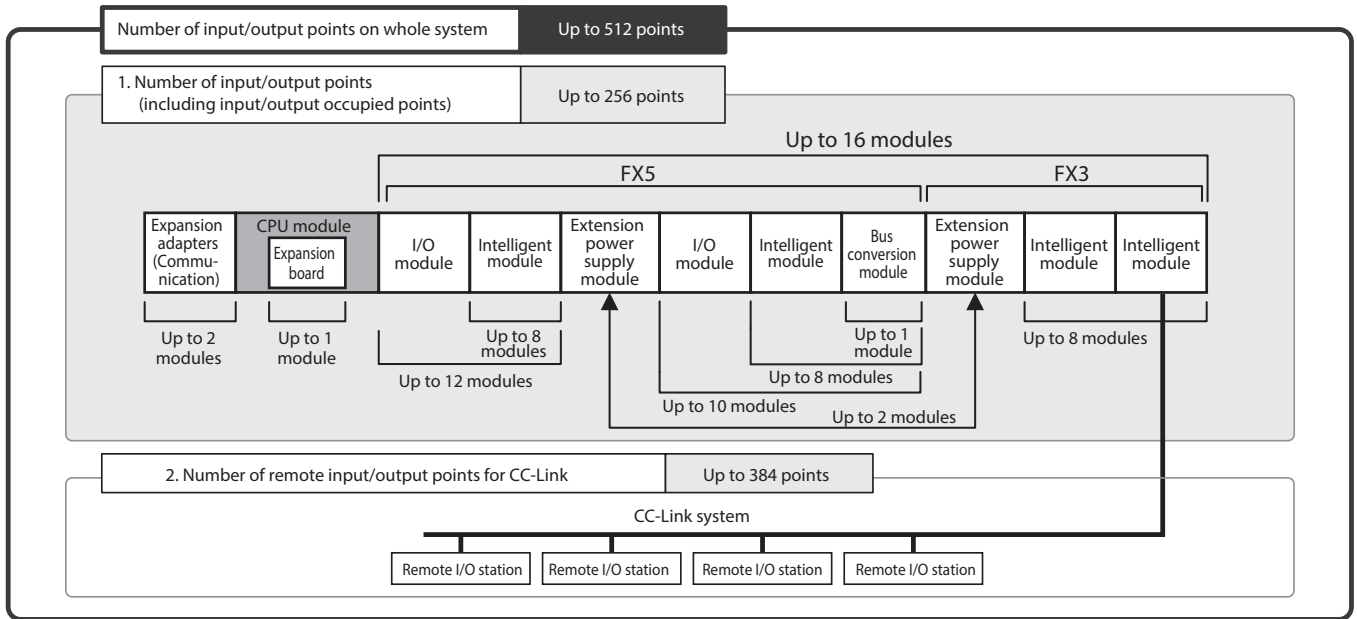

Option

Battery	SD Card
FX3u-32BL	L1MEM-2GBSD L1MEM-4GBSD

Rules of System Configuration



Expansion Modules

I/O Modules			Intelligent Function Modules		Extension Power Supply Module
Powered I/O Modules  Powered Input/Output FX5-32ER/ES FX5-32ET/ES FX5-32ET/ESS	Unpowered I/O Modules  Input FX5-8EX/ES FX5-16EX/ES	Output FX5-8EYR/ES FX5-8EYT/ES FX5-8EYT/ESS FX5-16EYR/ES FX5-16EYT/ES FX5-16EYT/ESS	 Simple Motion FX5-40SSC-S	 Network CC-Link/IE Field slave ... Future support	 Power Supply FX5-1PSU-5V

Bus Conversion Module



Bus Conversion
FX5-CNV-BUS

FX3U Expansion Modules

Extension Power Supply Module	FX3U Intelligent Modules																
 Power Supply FX3U-1PSU-5V	<table border="1"> <thead> <tr> <th>Analog</th> <th>Positioning</th> <th colspan="2">Network</th> </tr> </thead> <tbody> <tr> <td>FX3U-4AD FX3U-4DA</td> <td>FX3U-1PG</td> <td>FX3U-64CCL FX3U-32DP</td> <td>FX3U-16CCL-M FX3U-64DP-M</td> </tr> <tr> <th>Temperature</th> <th>High Speed Counter</th> <td colspan="2"></td> </tr> <tr> <td>FX3U-4LC</td> <td>FX3U-2HC</td> <td colspan="2"></td> </tr> </tbody> </table> <p>FX3U intelligent function modules must be set up by PLC program. Parameter setup is not available in GX Works3.</p>	Analog	Positioning	Network		FX3U-4AD FX3U-4DA	FX3U-1PG	FX3U-64CCL FX3U-32DP	FX3U-16CCL-M FX3U-64DP-M	Temperature	High Speed Counter			FX3U-4LC	FX3U-2HC		
Analog	Positioning	Network															
FX3U-4AD FX3U-4DA	FX3U-1PG	FX3U-64CCL FX3U-32DP	FX3U-16CCL-M FX3U-64DP-M														
Temperature	High Speed Counter																
FX3U-4LC	FX3U-2HC																

CPU module specification

Generic Specifications

Item	Specifications				
Operating ambient temperature*1	0 to 55°C (32 to 131°F)*2				
Storage ambient temperature	-25 to 75°C(-13 to 167°F)				
Operating ambient humidity	5 to 95%RH, non-condensation				
Storage ambient humidity	5 to 95%RH, non-condensation				
Vibration resistance*2	—	Frequency	Acceleration	Half amplitude	Sweep count
	Installed on DIN rail	5 to 8.4 Hz	—	1.75 mm	10 times each in X, Y, Z directions (80 min in each direction)
	Direct installing	8.4 to 150 Hz	4.9 m/s ²	—	
		5 to 8.4 Hz	—	3.5 mm	
	8.4 to 150 Hz	9.8 m/s ²	—		
Shock resistance*3	147 m/s ² , Action time: 11 ms, 3 times by half-sine pulse in each direction X, Y, and Z				
Noise durability	By noise simulator at noise voltage of 1000 Vp-p, noise width of 1 μs and period of 30 to 100 Hz				
Grounding	Class D grounding (grounding resistance: 100 Ω or less) <Common grounding with a heavy electrical system is not allowed.>*4				
Operating atmosphere	Free from corrosive or flammable gas and excessive conductive dust				
Operating altitude*5	0 to 2000 m				
Installation location	Inside a control panel				
Overvoltage category	II or less				
Pollution degree*6	2 or less				
Equipment class	Class 2				

*1 : The simultaneous ON ratio of available PLC inputs or outputs changes with respect to the ambient temperature, refer to manuals of each product.

*2 : For details on Intelligent function modules, refer to manuals of each product.

*3 : The criterion is shown in IEC61131-2.

*4 : Ground the PLC independently or jointly.

*5 : The PLC cannot be used at a pressure higher than the atmospheric pressure to avoid damage.

*6 : This index indicates the degree to which conductive material is generated in the environment in which the equipment is used. Pollution level 2 is when only non-conductive pollution occurs. Temporary conductivity caused by condensation must be expected occasionally.

Power Supply Specifications

Item	Specifications			
	FX5U-32M	FX5U-64M	FX5U-80M	
Rated voltage	100 to 240 V AC			
Allowable supply voltage range	85 to 264 V AC			
Frequency rating	50/60 Hz			
Allowable instantaneous power failure time	Operation can be continued upon occurrence of instantaneous power failure for 10 ms or less.			
Power fuse	250 V, 3.15 A Time-lag fuse	250 V, 5 A Time-lag fuse		
Rush current	25 A max. 5 ms or less/100 V AC 50 A max. 5 ms or less/200 V AC	30 A max. 5 ms or less/100 V AC 60 A max. 5 ms or less/200 V AC		
Power consumption*1	30 W	40 W	45 W	
5 V DC power supply capacity	900 mA	1100 mA	1100 mA	
24 V DC service power supply capacity*2	When service power supply is used for input circuits	400 mA	600 mA	600 mA
	When external power supply is used for input circuits	480 mA	740 mA	770 mA

*1 : This value is for when all 24 V DC service power supplies are used in the maximum configuration in which they can be connected to the CPU module. The input current is included.

*2 : When I/O modules are connected, they consume current from the 24 V DC service power.

Performance Specifications

Item	Specifications	
Control system	Stored-program repetitive operation	
Input/output control system	Refresh system (Direct access input/output allowed by specification of direct access input/output (DX, DY))	
Programming specifications	Programming language	Ladder diagram (LD), structured text (ST)
	Programming extension function	Function block (FB), structured ladder, label programming (local/global)
	Constant scan	0.2 to 2000 ms (can be set in 0.1 ms increments)
	Fixed cycle interrupt	1 to 60000 ms (can be set in 1 ms increments)
	Timer performance specifications	100 ms, 10 ms, 1 ms
	No. of program executions	32
Operation specifications	Execution type	Standby type, initial execution type, scan execution type, event execution type
	Interrupt type	Internal timer interrupt, interrupt from input, high-speed comparison match interrupt
Command processing time	LD X0	34 ns
	MOV D0 D1	34 ns
Memory capacity	Program capacity	64 K steps (128 Kbytes)
	SD memory card	Memory card capacity (SD/SDHC memory card: Max. 4 Gbytes)
	Device/label memory	120 Kbytes
	Data memory/standard ROM	5 Mbytes
Flash memory write count	Maximum 20000 times	
File storage capacity	Device/label memory	1
	Data memory P: No. of program files/FB: No. of FB files	P: 32, FB: 16
Clock function	Display data	Year, month, day, hour, minute, second, day of week (leap year automatic detection)
	Precision	-2.96 to +3.74 s (TYP.+1.42 s/d at 0°C (32°F)) -3.18 to +3.74 s (TYP.+1.50 s/d at 25°C (77°F)) -13.20 to +2.12 s (TYP.-3.54 s/d at 55°C (131°F))
No. of input/output points	(1) No. of input/output points	256 points or less
	(2) No. of remote I/O points	384 points or less
	Total No. of points of (1) and (2)	512 points or less
Power failure retention*1	Retention method	Large-capacity capacitor
	Retention time	10 days
	Data retained	Clock data

*1 : The retention period of a fully charged capacitor (electricity is conducted across the PLC for at least 30 minutes) is 10 days (ambient temperature: 25°C (77°F)).

Number of device points

Item	Base	Max. number of points	
No. of user device points			The total number of input/output points must not exceed 256 points.
Input relay (X)	8	1024 points	
Output relay (Y)	8	1024 points	
Internal relay (M)	10	32768 points (can be changed with parameter)*1	
Latch relay (L)	10	32768 points (can be changed with parameter)*1	
Link relay (B)	16	32768 points (can be changed with parameter)*1	
Annunciator (F)	10	32768 points (can be changed with parameter)*1	
Link special relay (SB)	16	32768 points (can be changed with parameter)*1	
Step relay (S)	10	4096 points (fixed)	
Timer system	Timer (T)	10	1024 points (can be changed with parameter)*1
	Accumulation timer system Accumulation timer (ST)	10	1024 points (can be changed with parameter)*1
Counter system	Counter (C)	10	1024 points (can be changed with parameter)*1
	Long counter (LC)	10	1024 points (can be changed with parameter)*1
Data register (D)	10	8000 points (can be changed with parameter)*1	
Link register (W)	16	32768 points (can be changed with parameter)*1	
Link special register (SW)	16	32768 points (can be changed with parameter)*1	
No. of system device points	Special relay (SM)	10	10000 points (fixed)
	Special register (SD)	10	12000 points (fixed)

*1 : Can be changed with parameters within the capacity range of the CPU built-in memory.

*2 : Total of the index register (Z) and long index register (LZ) is maximum 24 words.

Item	Base	Max. number of points	
Module access device	10	65536 points (designated by U□, G□)	
No. of index register points	10	24 points	
	10	12 points	
No. of file register points	10	32768 points (can be changed with parameter)*1	
No. of nesting points	10	15 points (fixed)	
No. of pointer points	Pointer (P)	10 4096 points	
	Interrupt pointer (I)	10 178 points (fixed)	
Others	Decimal constant (K)	Signed	16 bits: -32768 to 32767, 32 bits: -2147483648 to 2147483647
		Unsigned	16 bits: 0 to 65535, 32 bits: 0 to 4294967295
	Hexadecimal constant (H)	16 bits: 0 to FFFF, 32 bits: 0 to FFFFFFFF	
	Real constant (E)	Single precision E-3.40282347+38 to E-1.17549435-38, 0, E1.17549435-38 to E3.40282347+38	
Character string	—	Shift-JIS code max. 255 single-byte characters (256 including NULL)	

□ Input Specifications

24 V DC input (sink/source)

Item	Specifications		
	FX5U-32M	FX5U-64M	FX5U-80M
No. of input points	16 points	32 points	40 points
Connection type	Removable terminal block (M3 screws)		
Input type	Sink/source		
Input signal voltage	24 V DC +20 %, -15%		
Input signal current	X000 to X017	5.3 mA/24 V DC	
	X020 and subsequent	4.0 mA/24 V DC	
Input impedance	X000 to X017	4.3 kΩ	
	X020 and subsequent	5.6 kΩ	
ON input sensitivity current	X000 to X017	3.5 mA or more	
	X20 and subsequent	3.0 mA or more	
OFF input sensitivity current	1.5 mA or less		
Input response frequency	X000 to X005	200 kHz	
	X006 to X017	10 kHz	
	X000 to X007	—	
	X006 to X017	200 kHz	
	X020 and subsequent	10 kHz	
Pulse waveform	Waveform		
	X000 to X005	T1: 2.5 μs or more, T2: 1.25 μs or more	
	X006 to X017	T1: 50 μs or more, T2: 25 μs or more	
	X000 to X007	—	
	X010 to X017	T1: 2.5 μs or more, T2: 1.25 μs or more	
Input response time (HW filter delay)	X000 to X005	ON: 2.5 μs or less, OFF: 2.5 μs or less	
	X006 to X017	ON: 30 μs or less, OFF: 50 μs or less	
	X000 to X007	—	
	X010 to X017	ON: 2.5 μs or less, OFF: 2.5 μs or less	
	X010 to X017	—	
Input response time (Digital filter setting value)	None, 10 μs, 50 μs, 0.1 ms, 0.2 ms, 0.4 ms, 0.6 ms, 1 ms, 5 ms, 10 ms, 20 ms, 70 ms When using the product in an environment with much noise, set the digital filter.		
Input signal format	No-voltage contact input Sink: NPN open collector transistor Source: PNP open collector transistor		
Input circuit configuration	• When using service power supply Sink input wiring Source input wiring 		
	• When using external power supply Sink input wiring Source input wiring 		

Analog input

Item	Specifications
Analog input points	2 points (2 channels)
Analog input Voltage	0 to 10 V DC (input resistance 115.7 kΩ)
Digital output	Unsigned 12-bit binary
I/O characteristics, Maximum resolution	Digital output value: 0 to 4000 Maximum resolution: 2.5 mV
Accuracy (Accuracy in respect to maximum digital output value)	Ambient temperature 25±5°C (77±41°F)
	Ambient temperature 0 to 55°C (32 to 131°F)
Conversion speed	30 μs/channel (data refreshed every operation cycle)
Absolute maximum input	-0.5 V, +15 V
Insulation method	Between input terminal and PLC
	Between input terminals
Occupied points	0 points (does not pertain to the max. No. of input/output points of the PLC.)
Terminal block used	European-type terminal block

*1 : "Digit" refers to digital values.

Built-in RS-485 communication

Item	Specifications
Transmission standards	Conforms to RS-485/RS-422 specifications
Data transmission speed	Max. 115.2 kbps
Communication method	Full duplex (FDX) / half duplex (HDX)
Maximum total extension distance	50 m (164' 0")
Protocol type	MELSOFT connection
	Non-protocol communication
	MODBUS RTU
	Inverter communication
Insulation method	Not insulated
Terminal resistors	Built-in (OPEN/110 Ω/330 Ω)
Terminal block used	European-type terminal block

□ Output Specifications

Relay output

Item	Output Specifications		
	FX5U-32M	FX5U-64M	FX5U-80M
No. of output points	16 points	32 points	40 points
Connection type	Removable terminal block (M3 screws)		
Output type	Relay		
External power supply	30 V DC or less 240 V AC or less ("250 V AC or less" if not a CE, UL, cUL compliant item)		
Max. load	2 A/point The total load current per common terminal should be the following value. • 4 output points/common terminal: 8 A or less • 8 output points/common terminal: 8 A or less		
	Min. load		
	5 V DC, 2 mA (reference values)		
Open circuit leakage current	—		
Response time	OFF→ON	Approx. 10 ms	
	ON→OFF	Approx. 10 ms	
Insulation of circuit	Mechanical insulation		
Indication of output operation	LED is lit when output is on		
Output circuit configuration			

A number is entered in the □ of [COM□].

Transistor output

Item	Output Specifications		
	FX5U-32M	FX5U-64M	FX5U-80M
No. of output points	16 points	32 points	40 points
Connection type	Removable terminal block (M3 screws)		
Output type	Transistor/sink output (FX5U-□MT/ES) Transistor/source output (FX5U-□MT/ESS)		
External power supply	5 to 30 V DC		
Max. load	0.5 A/point The total load current per common terminal should be the following value. • 4 output points/common terminal: 0.8 A or less • 8 output points/common terminal: 0.8 A or less		
	Open circuit leakage current		
Voltage drop when ON		Y000 to Y003: 1.0 V or less Y004 and subsequent: 1.5 V or less	
Response time	Y000 to Y003	2.5 μs or less/10 mA or more (5 to 24 V DC)	
	Y004 and subsequent	0.2 ms or less/200 mA or more (24 V DC)	
Insulation of circuit	Photo-coupler insulation		
Indication of output operation	LED is lit when output is on		
Output circuit configuration	Sink output wiring		Source output wiring

A number is entered in the □ of [COM□]. A number is entered in the □ of [+V□].

Analog output

Item	Specifications
Analog output points	1 points (1 channels)
Digital input	Unsigned 12-bit binary
Analog output Voltage	0 to 10 V DC (external load resistance 2 k to 1 MΩ)
I/O characteristics, Maximum resolution	Digital input value: 0 to 4000
	Maximum resolution: 2.5 mV
Accuracy (Accuracy in respect to maximum analog output value)	Ambient temperature 25±5°C (77±41°F)
	Ambient temperature 0 to 55°C (32 to 131°F)
Conversion speed	30 μs (data refreshed every operation cycle)
Insulation method	Between output terminal and PLC
Occupied points	0 points (does not pertain to the max. No. of input/output points of the PLC.)
Terminal block used	European-type terminal block

*1 : "Digit" refers to digital values.

Built-in Ethernet communication

Item	Specifications
Data transmission speed	100M/10M (bps)
Communication mode	Full duplex (FDX) / half duplex (HDX)
Transmission method	Base band
Maximum segment length	100 m (328' 1")
Cascade connection	10BASE-T
	100BASE-TX
Protocol type	MELSOFT connection
	SLMP (3E frame)
	Socket communication
Number of simultaneously open connections allowed	8 connections
Insulation method	Pulse transformer insulation
Interface	RJ45 connector
Cable used*2	For 10BASE-T connection
	For 100BASE-TX connection

*1 : Number of stages that can be connected when a repeater hub is used. When a switching hub is used, check the specifications of the switching hub used.

*2 : A straight cable can be used. If a personal computer and CPU module are directly connected (simple connection), a cross cable can be used.

Simple motion module specification

Control specification

Item	Specifications FX5-40SSC-S
Number of control axes (Virtual servo amplifier axis included)	Up to 4 axes
Operation cycle (Operation cycle settings)	1.777 ms
Interpolation function	Linear interpolation (Up to 4 axes), Circular interpolation (2 axes)
Control modes	PTP (Point To Point) control, Trajectory control (both linear and arc), Speed control, Speed-position switching control, Position-speed switching control, Speed-torque control
Acceleration/deceleration process	Trapezoidal acceleration/deceleration, S-curve acceleration/deceleration
Compensation function	Backlash compensation, Electronic gear, Near pass function
Synchronous control	Input axis Servo input axis, Virtual servo amplifier axis, Synchronous encoder axis Output axis Cam axis (Up to 4 axes)
Cam control	Number of registration Up to 64 (depending on memory capacity, cam resolution and number of coordinates) Cam data type Stroke ratio data type, Coordinate data type Cam auto-generation Cam auto-generation for rotary cutter
Control unit	mm, inch, degree, pulse
Number of positioning data	600 data (positioning data No. 1 to 600)/axis (Can be set with MELSOFT GX Works3 or a sequence program.)
Backup	Parameters, positioning data, and block start data can be saved on flash ROM (battery-less backup)
Home position return	Home position return method Proximity dog method, Count method 1, Count method 2, Data set method, Scale home position signal detection method Fast home position return control Provided Sub functions Home position return retry, Home position shift
Positioning control	Linear control 1-axis linear control, 2-axis linear interpolation control, 3-axis linear interpolation control, 4-axis linear interpolation control *1 (Composite speed, Reference axis speed) Fixed-pitch feed control 1-axis fixed-pitch feed, 2-axis fixed-pitch feed, 3-axis fixed-pitch feed, 4-axis fixed-pitch feed 2-axis circular interpolation Sub point designation, center point designation Speed control 1-axis speed control, 2-axis speed control, 3-axis speed control, 4-axis speed control Speed-position switching control INC mode, ABS mode Position-speed switching control INC mode Current value change Positioning data, Start No. for a current value changing NOP instruction Provided JUMP instruction Unconditional JUMP, Conditional JUMP LOOP, LEND Provided High-level positioning control Block start, Condition start, Wait start, Simultaneous start, Repeated start
Manual control	JOG operation Provided Inching operation Provided Manual pulse generator Possible to connect 1 module (Incremental), Unit magnification (1 to 10000 times)
Expansion control	Speed-torque control Speed control without positioning loops, Torque control, Tightening & press-fit control
Absolute position system	Made compatible by setting a battery to servo amplifier
Synchronous encoder interface	Up to 4 channels (Total of the internal interface, via PLC CPU interface, and servo amplifier interface)
Functions that limit control	Internal interface 1 channel (Incremental) Speed limit function Speed limit value, JOG speed limit value Torque limit function Torque limit value_same setting, torque limit value_individual setting Forced stop Valid/Invalid setting Software stroke limit function Movable range check with current feed value, movable range check with machine feed value Hardware stroke limit function Provided
Functions that change control details	Speed change function Provided Override function 1 to 300 [%] Acceleration/deceleration time change function Provided Torque change function Provided Target position change function Target position address and speed are changeable
Other functions	M-code output function Provided Step function Deceleration unit step, Data No. unit step Skip function Via PLC CPU, Via external command signal Teaching function Provided
Parameter initialization function	Provided
External input signal setting function	Via internal interface, CPU, servo amplifier
Amplifier-less operation function	Provided
Mark detection function	Regular mode, Specified Number of Detections mode, Ring Buffer mode Mark detection signal Up to 4 points Mark detection setting 4 settings
Optional data monitor function	4 points/axis
Driver communication function	Provided
SSCNET connect/disconnect function	Provided
Digital oscilloscope function*2	Bit data 16 ch Word data 16 ch

*1 : 4-axis linear interpolation control is enabled only at the reference axis speed.

*2 : 8 ch word data and 8CH bit data can be displayed in real time.

Module specification

Item	Specifications
Servo amplifier connection method	SSCNET III/H
Maximum overall cable distance [m(ft.)]	400 (1312.32)
Maximum distance between stations [m(ft.)]	100 (328.08)
Peripheral I/F	Via CPU module (Ethernet, RS-485)
Manual pulse generator operation function	Possible to connect 1 module
Synchronous encoder operation function	Possible to connect 4 modules (Total of the internal interface, via PLC CPU interface, and servo amplifier interface)
Input signals(DI)	Number of input points 4 points Input method Positive common/Negative common shared (Photocoupler isolation) Rated input voltage/current 24 V DC/ Approx. 5 mA Operating voltage range 19.2 to 26.4 V DC (24 V DC +10%/ -20%, ripple ratio 5% or less) ON voltage/current 17.5 V DC or more/ 3.5 mA or more OFF voltage/current 7 V DC or less/ 1.0 mA or less Input resistance Approx. 6.8 kΩ Response time 1 ms or less (OFF→ON, ON→OFF) Recommended wire size AWG24 (0.2 mm ²)
Forced stop input signal (EM1)	Number of input points 1 point Input method Positive common/Negative common shared (Photocoupler isolation) Rated input voltage/current 24 V DC/ Approx. 5 mA Operating voltage range 19.2 to 26.4 V DC (24 V DC +10%/ -20%, ripple ratio 5% or less) ON voltage/current 17.5 V DC or more/ 3.5 mA or more OFF voltage/current 7 V DC or less/ 1.0 mA or less Input resistance Approx. 6.8 kΩ Response time 4 ms or less (OFF→ON, ON→OFF) Recommended wire size AWG24 (0.2 mm ²)
Signal input form	Phase A/Phase B (magnification by 4/ magnification by 2/magnification by 1), PULSE/SIGN
Manual pulse generator/Incremental synchronous encoder signal	Differential output type (26LS31 or equivalent) Input pulse frequency Up to 1 Mpulse/s (After magnification by 4, up to 4 Mpulse/s) Pulse width 1 μs or more Leading edge/trailing edge time 0.25 μs or less Phase difference 0.25 μs or more Rated input voltage 5.5 V DC or less High voltage 2.0 to 5.25 V DC Low voltage 0 to 0.8 V DC Differential voltage ±0.2V Cable length Up to 30 m (98.43ft.)
Manual pulse generator/Incremental synchronous encoder signal	Voltage output/ Open collector type (5 V DC) Input pulse frequency Up to 200 kpulse/s (After magnification by 4, up to 800 kpulse/s) Pulse width 5 μs or more Leading edge/trailing edge time 1.2 μs or less Phase difference 1.2 μs or more Rated input voltage 5.5 V DC or less High voltage 3.0 to 5.25 V DC/2 mA or less Low voltage 0 to 1.0 V DC/5 mA or more Cable length Up to 10m (32.81ft.)
24 V DC internal current consumption	0.25 A
Mass	0.30 kg
Exterior dimensions [mm(inch)]	90.0(3.55)(H)×50.0(1.97)(W)×83.0(3.27)(D)

External Dimensions

Main Modules

Unit: mm (inches)

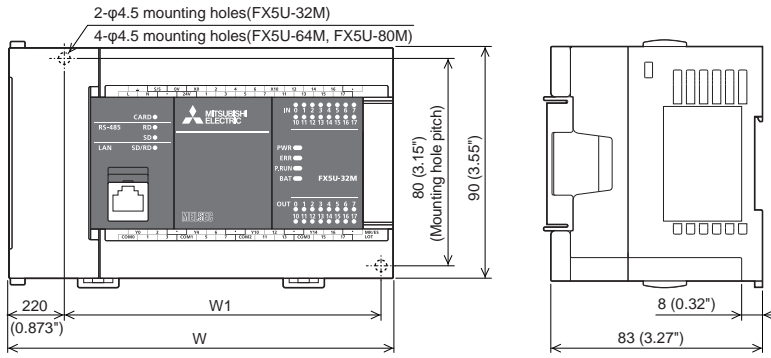

Model	W: mm (inches)	W1 (mounting hole pitch): mm (inches)	Mass (weight)
FX5U-32M	150 (5.91")	123 (4.85")	Approx. 0.65 kg (1.43" lbs)
FX5U-64M	220 (8.67")	193 (7.60")	Approx. 1.00 kg (2.2" lbs)
FX5U-80M	285 (11.23")	258 (10.16")	Approx. 1.20 kg (2.64" lbs)

- Exterior color : Main body: Munsell 0.6B7.6/0.2
- Accessories : Dust proof protection sheet, Manual supplied with product

Expansion Modules

I/O Modules

Unit: mm (inches)

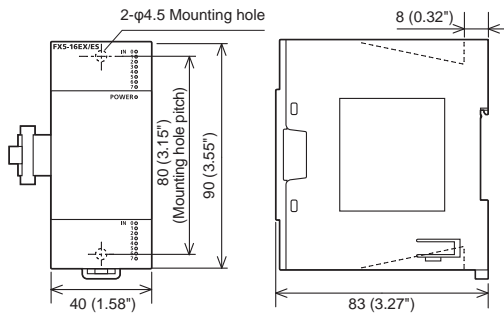

Model	Mass (weight)
FX5-8EX/ES, FX5-8EYR/ES, FX5-8EYT/ES, FX5-8EYT/ESS	Approx. 0.2 kg (0.44" lbs)
FX5-16EX/ES, FX5-16EYR/ES, FX5-16EYT/ES, FX5-16EYT/ESS	Approx. 0.25 kg (0.551" lbs)

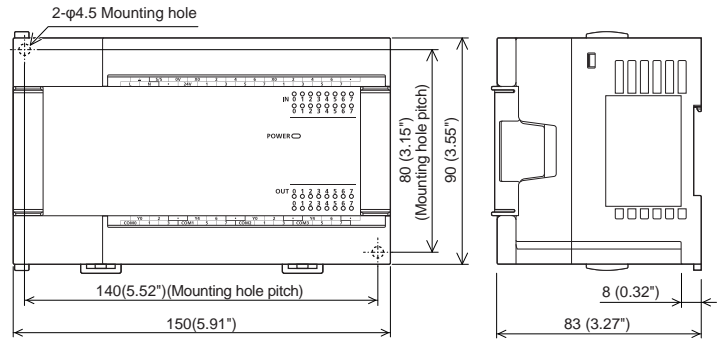

Model	Mass (weight)
FX5-32ER/ES, FX5-32ET/ES, FX5-32ET/ESS	Approx. 0.65 kg (1.43" lbs)

Intelligent Function Module

FX5-40SSC-S

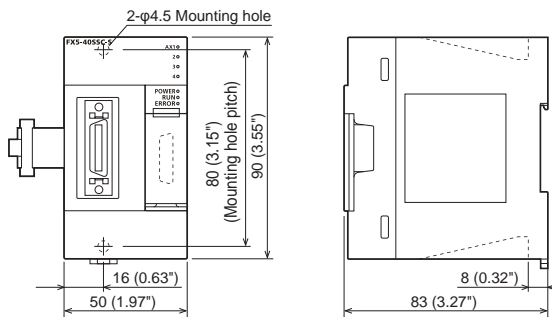

Extension Power Supply Module

FX5-1PSU-5V

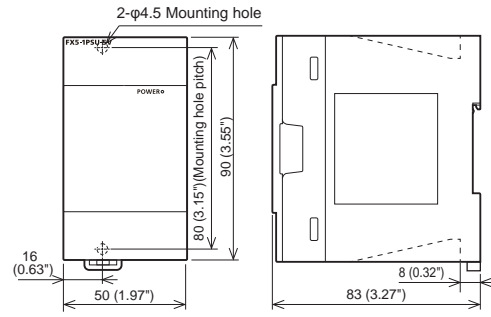

Expansion Adapters

FX5-232ADP / FX5-485ADP

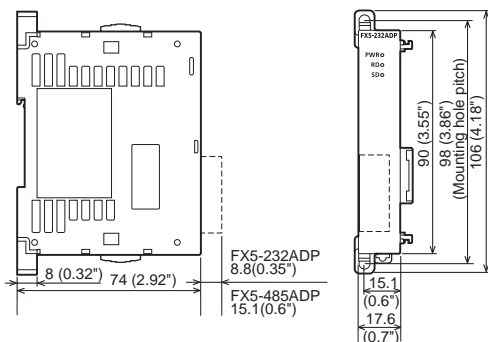

Bus Conversion Module

FX5-CNV-BUS

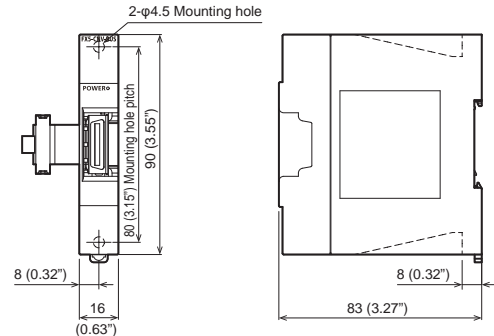

Products list

CPU & I/O module

Model	Specification			
	Power Supply	Input		Output
FX5U-32MR/ES	100 to 240 V AC 50/60 Hz	16 points	24 V DC Sink/source	16 points
FX5U-32MT/ES				Relay
FX5U-32MT/ESS				Transistor/sink
FX5U-64MR/ES		32 points		32 points
FX5U-64MT/ES				Relay
FX5U-64MT/ESS		Transistor/sink		
FX5U-80MR/ES		40 points		40 points
FX5U-80MT/ES				Relay
FX5U-80MT/ESS	Transistor/sink			
FX5-8EX/ES	Power supply from CPU module	8 points	24 V DC Sink/source	—
FX5-16EX/ES		16 points		—
FX5-8EYR/ES		—		8 points
FX5-8EYT/ES		—		Relay
FX5-8EYT/ESS		—		Transistor/sink
FX5-16EYR/ES		—		16 points
FX5-16EYT/ES		—		Relay
FX5-16EYT/ESS		—		Transistor/sink
FX5-32ER/ES	100 to 240 V AC 50/60 Hz	16 points	24 V DC Sink/source	16 points
FX5-32ET/ES				Relay
FX5-32ET/ESS				Transistor/sink

Expansion modules

Model	Specification
FX5-40SSC-S	Simple motion module
FX5-1PSU-5V	Extension power supply module
FX5-CNV-BUS	Bus conversion module

Expansion Boards & Adapters

Model	Specification
FX5-232-BD	For RS-232C communication
FX5-485-BD	For RS-485 communication
FX5-422-BD-GOT	For GOT RS-422 communication
FX5-232ADP	For RS-232C communication
FX5-485ADP	For RS-485 communication

Option

Model	Specification
FX3u-32BL	Option battery

User's manuals for the applicable modules

Manual name <manual number>	Description
MELSEC iQ-F series FX5U Hardware Manual <JY997D53401>	Describes the details of input/output specifications, wiring and installation of the FX5U CPU module from FX5U User's Manual [Hardware].
MELSEC iQ-F series FX5U User's Manual [Hardware]<JY997D55301>	Describes the details on hardware of the FX5U series CPU module, including input/output specifications, wiring, installation, and maintenance.
MELSEC iQ-F series FX5 User's Manual [Application]<JY997D55401>	Describes basic knowledge required for program design, functions of the CPU module, devices/labels, and parameters.
MELSEC iQ-F series FX5 Programming Manual [Program Design]<JY997D55701>	Describes specifications of ladders, ST, and other programs and of labels.
MELSEC iQ-F series FX5 Programming Manual [Instructions, Functions]<JY997D55801>	Describes specifications of instructions and functions that can be used in programs.
MELSEC iQ-F series FX5 User's Manual [Serial Communication]<JY997D55901>	Describes inverter communication, and non-protocol communication.
MELSEC iQ-F series FX5 User's Manual [MODBUS Communication]<JY997D56101>	Describes MODBUS serial communication.
MELSEC iQ-F series FX5 User's Manual [Ethernet Communication]<JY997D56201>	Describes the functions of the built-in Ethernet port communication function.
MELSEC iQ-F series FX5 User's Manual [Positioning Control]<JY997D56301>	Describes the built-in positioning function.
FX5 Series User's Manual [Startup]<JY997D55301>	Performance specifications, procedures before operation, and troubleshooting of the CPU module.

About this product catalog

Due to the constantly growing product range and new or changed product features, the information in this catalog may be updated without notice. Please contact your Mitsubishi Electric product provider for more details. Texts, figures and diagrams shown in this product catalog are intended exclusively for explanation and assistance in planning and ordering the FX5 programmable logic controllers (PLCs) and the associated accessories. Only the manuals supplied with the units are relevant for installation, commissioning and handling of the units and the accessories. The information given in the manuals must be read before installation and commissioning of the units or software. If any questions arise regarding the application or use of the PLC units and accessories described in this catalog, please contact your Mitsubishi Electric product provider.

This catalog confers no industrial property rights or any rights of any other kind, nor does it confer any patent licenses. Mitsubishi Electric Corporation cannot be held responsible for any problems involving industrial property rights which may occur as a result of using the contents noted in this catalog.

©2014 MITSUBISHI ELECTRIC CORPORATION

- Ethernet is a trademark of Xerox Corporation.
- MODBUS is a registered trademark of Schneider Electric SA.
- All other company names and product names used in this document are trademarks or registered trademarks of their respective companies.

Mitsubishi Electric Corporation Himeji Works is a factory certified for ISO14001 (standards for environmental management systems) and ISO9001(standards for quality assurance management systems)



PROGRAMMABLE CONTROLLERS

mitsubishi electric corporation

HEAD OFFICE: TOKYO BLDG., 2-7-3, MARUNOUCHI, CHIYODA-KU, TOKYO 100-8310, JAPAN
<http://Global.MitsubishiElectric.com>
